

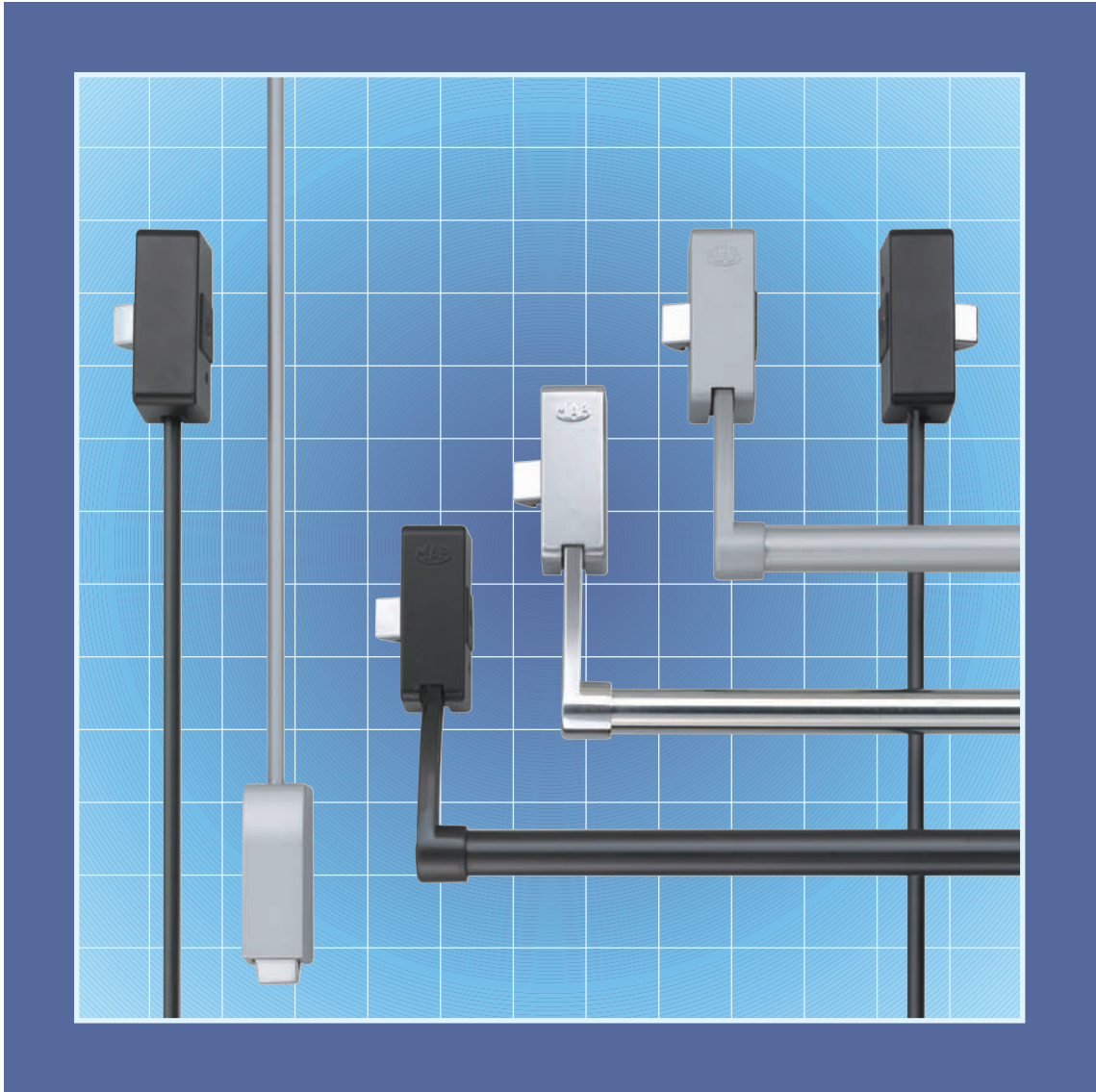

ASSA ABLOY



**MANIGLIONE
ANTIPANICO
COMPONIBILE**



**MODULAR
PANIC
EXIT DEVICE**

**MAB SEMPRE
QUANDO
C'È UNA PORTA**

**MAB MAKES
DOOR
CLOSING EASY**



CARATTERISTICHE:

- gamma ambidestra componibile
- 2 oppure 3 punti di chiusura aggiungendo il modulo di trasformazione (optional)
- utilizzabile su porte in legno o metallo con o senza fascia centrale
- sporgenza ridotta
- estrema semplicità di montaggio
- fermo a giorno (optional)
- finitura meccanismi: nero, argento e cromo
- finitura barre: nero, inox lucido, inox satinato e rosso (RAL 3000)
- certificato secondo la Norma Europea **EN 1125:97 / A1:2001** e marcato **CE** con classificazione:

FEATURES:

- modular non handed range
- 2 or 3 locking points by using transformation kit (optional)
- universal for timber, hollow-core metal, narrow stile aluminium doors
- low projection
- dogging device (optional)
- ease of installation
- finish of mechanisms: black, silver and chrome
- finish of cross bar: black, polished stainless steel, satin stainless steel and red (RAL 3000)
- certified according to European Standards **EN 1125:97 / A1: 2001** and **CE** marked with following classification:

3	7	6	0	1	4	2	2	A
---	---	---	---	---	---	---	---	---

MODELLI DISPONIBILI

(.xx : sostituire con codice finitura richiesta)

M1040:

- M104R.xx meccanismo con scrocco laterale ambidestro
- A0227.xx barra mm. 995.

M1440:

- M144R.xx meccanismo con scrocco laterale ambidestro con fermo a giorno
- A0227.xx barra mm. 995.

M1043:

- M104R.xx meccanismo con scrocco laterale ambidestro
- A0191.xx barra mm. 1500.

M1443:

- M144R.xx meccanismo con scrocco laterale ambidestro con fermo a giorno
- A0191.xx barra mm. 1500.

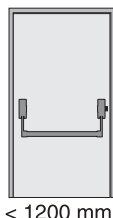

< 1200 mm.

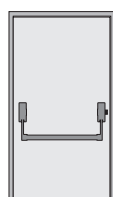

> 1200 mm.

AVAILABLE MODELS

(.xx : replace with desired finish code)

M1040:

- M104R.xx non handed side latch mechanism
- A0227.xx cross bar mm. 995.

M1440:

- M144R.xx non handed side latch mechanism with dogging device
- A0227.xx cross bar mm.995.

M1043:

- M104R.xx non handed side latch mechanism
- A0191.xx cross bar mm. 1500.

M1443:

- M144R.xx non handed side latch mechanism with dogging device
- A0191.xx cross bar mm. 1500.

POSSIBILI CHIUSURE

POSSIBLE MOUNTINGS

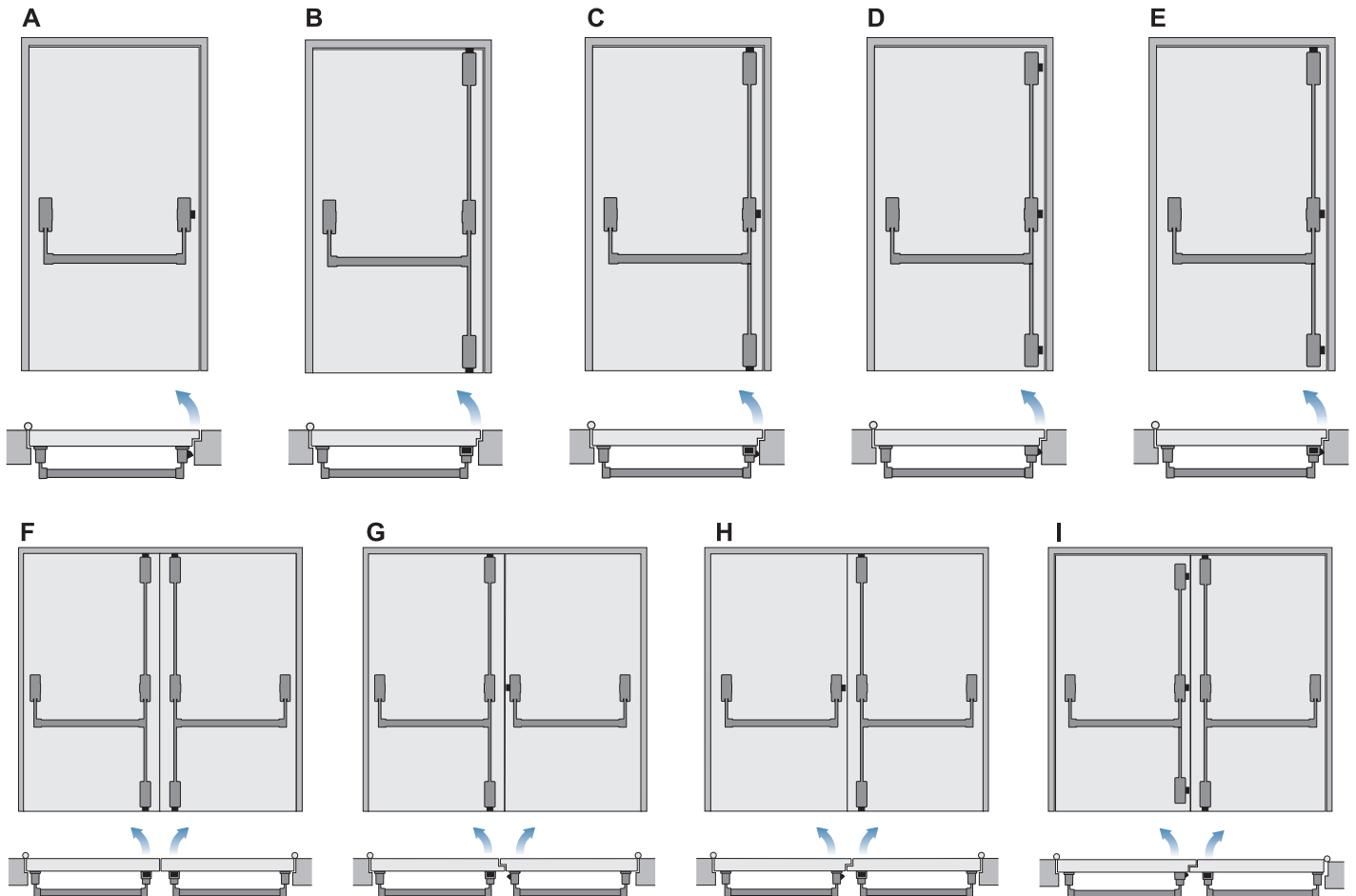

PORTA TIPO / DOOR TYPE	M1040	A0223	A0273	A0292	MANIGLIA HANDLE
A	●				●
B*	●	●			●
C	●	●			●
D	●		●		●
E	●			●	●
F	●●	●●			●●
G	●●	●			●
H	●●	●			●
I	●●	●	●		●

Nota bene:

- le illustrazioni si riferiscono a porte di max. 1200 x 2500 mm. Per porte più larghe o più alte, selezionare gli articoli specificati nelle sezioni **“Modelli disponibili”** e **“Moduli”**;
- la maniglia TIRAAPRI si intende opzionale;
- A0292: la porta raffigurata è sinistra, per porta destra utilizzare A0291 (vedi **“Moduli”**);

* i due punti verticali si ottengono inibendo lo scrocco laterale centrale con la linguetta di corredo.

Please Note:

- figures refer to maximum door size 1200 x 2500 mm. For larger or higher doors, please select articles from **“Available models”** and **“Kits”** sections;
- handle TIRAAPRI is optional;
- A0292: drawn door is left, for right doors please use A0291 (see **“Kits”**);

* two vertical locking points are obtained by deactivating centre side latch with plug provided .

MANIGLIA TIRAAPRI

TIRAAPRI HANDLE

CARATTERISTICHE:

- La maniglia **ambidestra** TIRAAPRI permette di aprire dall'esterno, **con il movimento più spontaneo e naturale**, una porta dotata di maniglione EXIT1000.
- Montaggio semplice e veloce.
- Cilindro Europeo premontato, per porte di spessore fino a 90 mm.
- Finitura: nero, argento, cromato.















Cilindro europeo
Europrofile cylinder

FEATURES:

- The **non handed** TIRAAPRI handle requires minimal effort to pull open, **with the most spontaneous and natural hand movement**, any door equipped with EXIT1000 panic devices.
- Installation easy and fast.
- Cylinder to fit any door thickness, up to 90 mm.
- Finish: black, silver, chrome.

FINITURE

Nota: per alcuni accessori non si applicano tutte queste finiture ( **ACCESSORI**, codice articolo)

A0     .30 nero / black
A0     .A0 argento / silver
A0     .X0 cromato / chromed

FINISHES

Note: some accessories are not available in all these finishes ( **ACCESSORIES**, article reference)

DIMENSIONI

DIMENSIONS

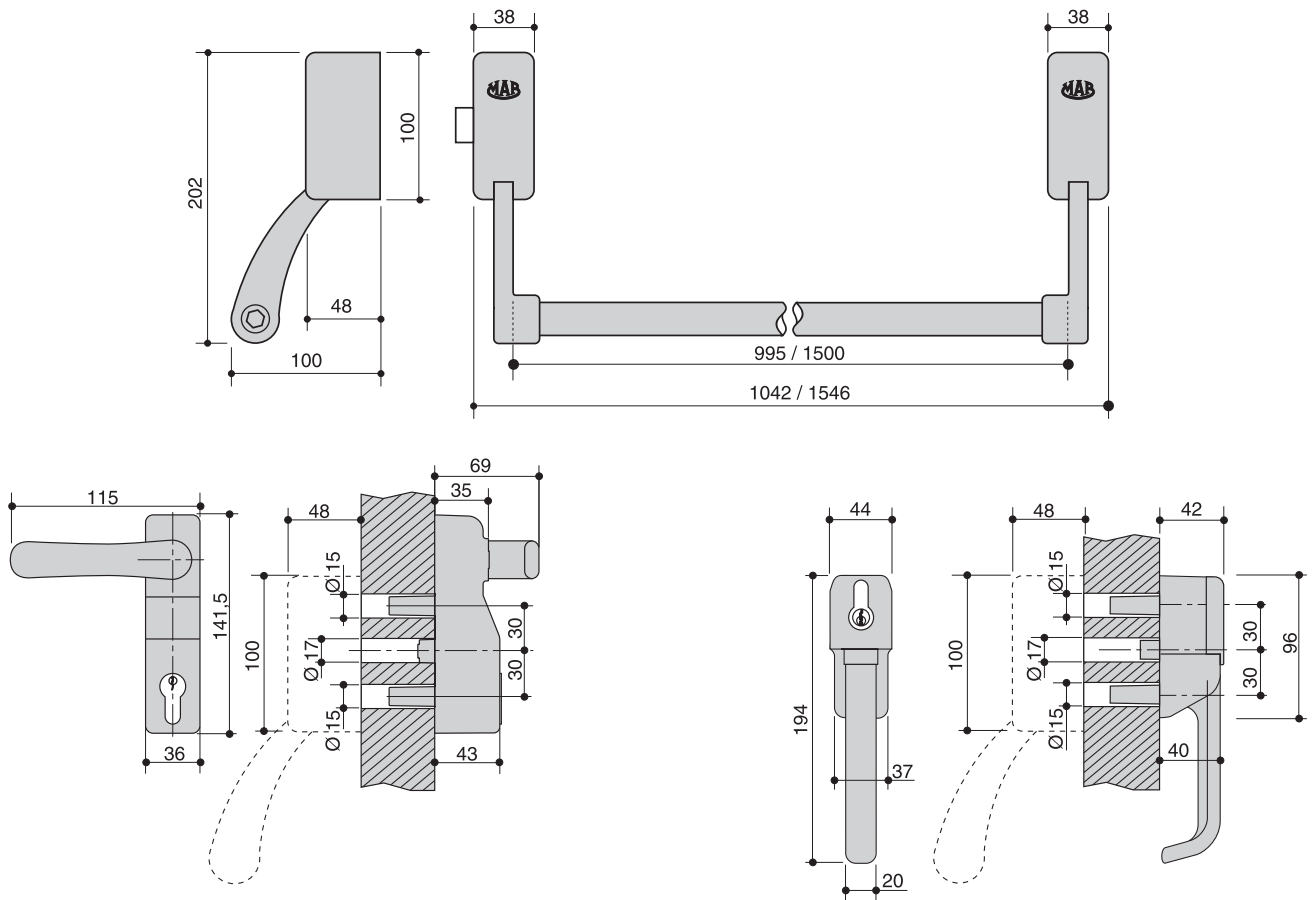

MANO DELLA PORTA

HANDING

PORTA SINISTRA

LEFT DOOR

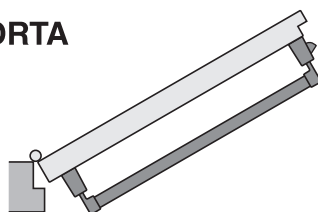

PORTA DESTRA

RIGHT DOOR

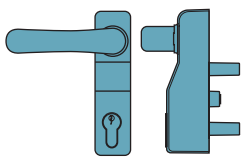

A0916.30
 Maniglia a rotazione con serratura a cilindro europeo. La porta può rimanere apribile dall'esterno con la maniglia.
 Lever handle with **locking cylinder**.
 The key can be taken away and the door can be left unlocked.

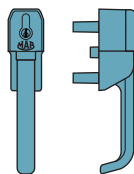

A0416
 Maniglia verticale TIRAAPRI con serratura a cilindro europeo. La porta può rimanere apribile dall'esterno con la maniglia.
 TIRAAPRI handle with **locking cylinder**.
 The key can be taken away and the door can be left unlocked.

A0917.30
 Maniglia a rotazione con serratura a cilindro europeo. La porta si apre solo utilizzando la chiave.
 Togliendo la chiave, la porta rimane sempre chiusa.

Lever handle with **opening cylinder**. The door can be opened only by key holder. When the key is taken away, the door is always locked.

A0417
 Maniglia verticale TIRAAPRI con serratura a cilindro europeo. La porta si apre solo utilizzando la chiave.
 Togliendo la chiave, la porta rimane sempre chiusa.

TIRAAPRI handle with **opening cylinder**. The door can be opened only by key holder. When the key is taken away, the door is always locked.

A0224

Coppia di aste verticali per porte di altezza max. mm. 2500.



Pair of vertical rods for doors up to 2500 mm. max. height.

A0225

Coppia aste verticali per porte di altezza max. mm. 3500.

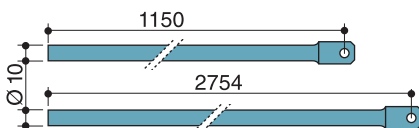

Pair of vertical rods for doors up to 3500 mm. max. height.

A0395

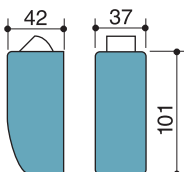

Scrocco verticale.
 Vertical latch.

A0396

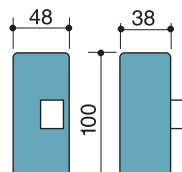

Scrocco laterale superiore destro / inferiore sinistro.

A0397

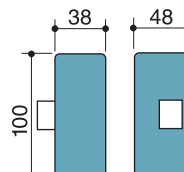

Scrocco laterale superiore sinistro / inferiore destro.

A0259.J0

Cilindro a profilo europeo nichelato.
 Europrofile cylinder nickel-plated.

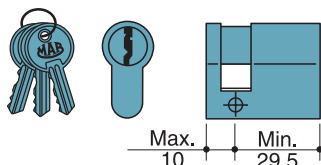

A0259.J2

Cilindro a profilo europeo cifratura unica nichelato.
 Europrofile cylinder with same key nickel-plated.

A0418.30

Incontro elettrico. Funzionamento a corrente di lavoro 12V AC/DC. Apertura ad un solo impulso. Colore nero.

Electric-Release strike. Power supply 12V AC/DC. Release by single electric impulse. Finish: black.

A0419.30

Incontro elettrico. Funzionamento a corrente di lavoro 12V AC/DC. Apertura ad impulso mantenuto. Colore nero.

Electric-Release strike. Power supply 12V AC/DC. Release by continuous electric impulse. Finish: black.



A0197.30

nero.
 black.

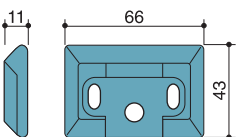

Incontro per alto e basso.
 Top or bottom striker.

A0197.X0

cromato.
 chromed.

A0198.30

nero.
 black.

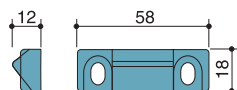

Incontro laterale.
 Side striker.

A0198.X0

cromato.
 chromed.

A0227

Barra in acciaio 995 mm.
 Steel cross bar 995 mm.

- A0227.30** nero / black
- A0227.I0** inox lucido / polished stainless steel
- A0227.Q0** inox satinato / satin stainless steel
- A0227.F0** rosso / red

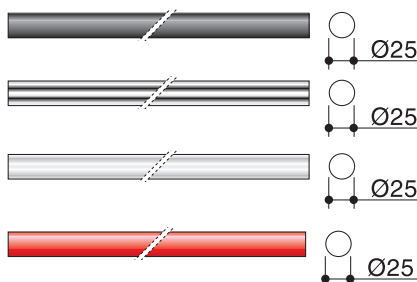

A0191

Barra in acciaio 1500 mm.
 Steel cross bar 1500 mm.

- A0191.30** nero / black
- A0191.I0** inox lucido / polished stainless steel
- A0191.Q0** inox satinato / satin stainless steel
- A0191.F0** rosso / red

A0223

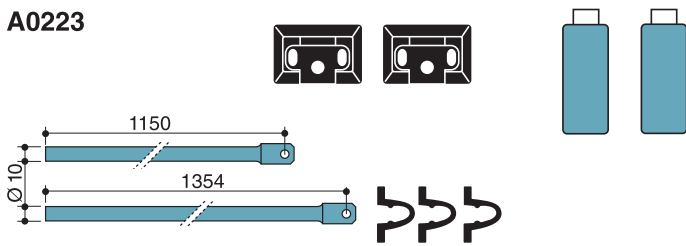

kit di trasformazione comprendente: No. 2 scrocci verticali **ambidestri**, No. 2 incontri, No. 2 aste per porte fino a massimo 2500 mm. di altezza, No. 3 guida aste.

kit comprises: No. 2 **non handed** vertical latches, No. 2 strikers, No. 2 vertical rods up to mm. 2500 max. height, No. 3 guides.

A0234

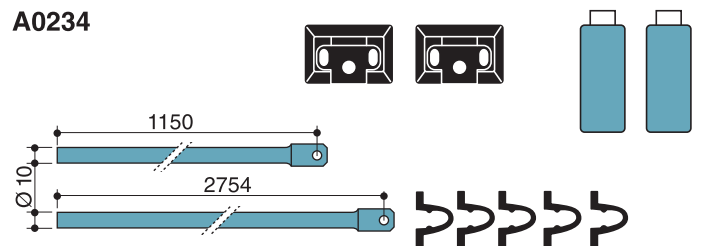

kit di trasformazione comprendente: No. 2 scrocci verticali **ambidestri**, No. 2 incontri, No. 2 aste per porte fino a massimo 3500 mm. di altezza, No. 5 guida aste.

kit comprises: No. 2 **non handed** latches, No. 2 strikers, No. 2 vertical rods up to mm. 3500 max. height, No. 5 guides.

A0273

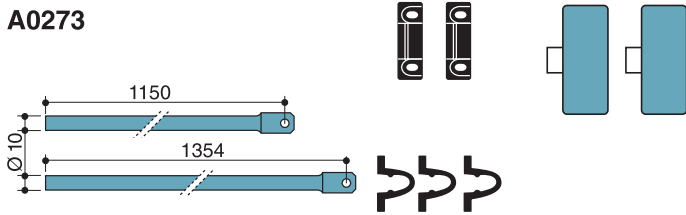

kit di trasformazione comprendente: No. 2 scrocci laterali **ambidestri**, No. 2 incontri laterali, No. 2 aste per porte fino a massimo 2500 mm. di altezza, No. 3 guida aste.

kit comprises: No. 2 **non handed** side latches, No. 2 strikers, No. 2 vertical rods for doors up to mm. 2500 height, No. 3 guides.

A0274

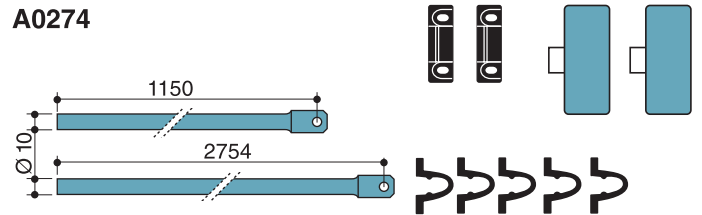

kit di trasformazione comprendente: No. 2 scrocci laterali **ambidestri**, No. 2 incontri laterali, No. 2 aste per porte fino a massimo 3500 mm di altezza, No. 5 guida aste.

kit comprises: No. 2 **non handed** side latches, No. 2 strikers, No. 2 vertical rods for doors up to mm 3500 height, No. 5 guides.

A0291

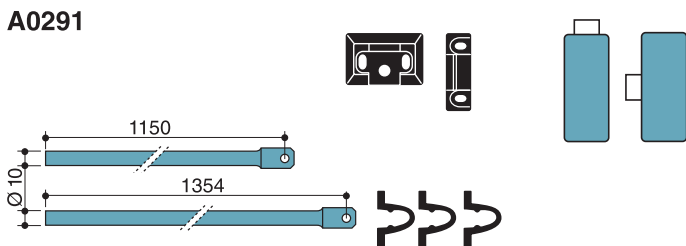

kit di trasformazione comprendente: No.1 scrocco verticale superiore e No. 1 scrocco laterale inferiore per **porte destre**, No.1 incontro alto e No.1 laterale, No. 2 aste per porte fino a massimo 2500 mm. di altezza, No. 3 guida aste.

kit comprises: No.1 top vertical latch, No.1 bottom side latch for **right hand doors**, No.1 vertical and No.1 lateral strikers, No. 2 vertical rods for doors up to mm. 2500 height, No. 3 guides.

A0293

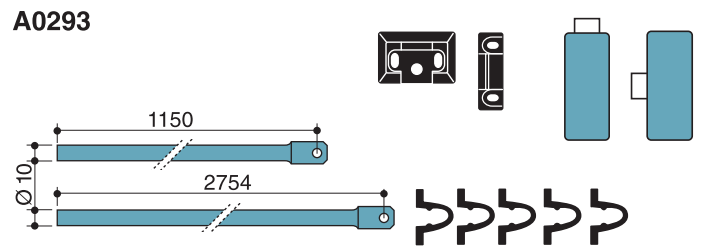

kit di trasformazione comprendente: No.1 scrocco verticale superiore e No. 1 scrocco laterale inferiore per **porte destre**, No.1 incontro alto e No.1 laterale, No. 2 aste per porte fino a massimo 3500 mm. di altezza, No. 5 guida aste.

kit comprises: No.1 top vertical latch, No.1 bottom side latch for **right hand doors**, No.1 vertical and No.1 lateral strikers, No. 2 vertical rods for doors up to mm. 3500 height, No. 5 guides.

A0292

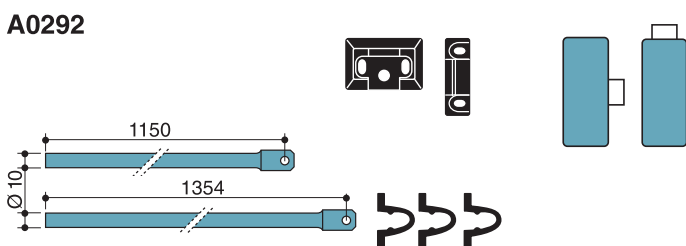

kit di trasformazione comprendente: No.1 scrocco verticale superiore e No. 1 scrocco laterale inferiore per **porte sinistre**, No. 1 incontro alto e No. 1 laterale, No. 2 aste per porte fino a massimo 2500 mm di altezza, No. 3 guida aste.

kit comprises: No. 1 top vertical latch, No. 1 bottom side latch for **left hand doors**, No. 1 vertical and No. 1 side strikers, No. 2 vertical rods for doors up to mm. 2500 height, No. 3 guides.

A0294

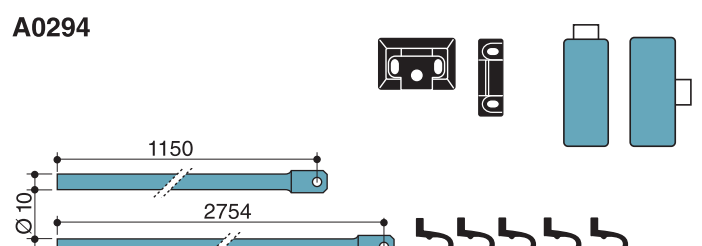

kit di trasformazione comprendente: No.1 scrocco verticale superiore e No. 1 scrocco laterale inferiore per **porte sinistre**, No.1 incontro alto e No. 1 laterale, No. 2 aste per porte fino a massimo 3500 mm. di altezza, No. 5 guida aste.

kit comprises: No. 1 top vertical latch, No. 1 bottom side latch for **left hand doors**, No. 1 vertical and No. 1 side strikers, No. 2 vertical rods for doors up to mm. 3500 height, No. 5 guides.

ASSA ABLOY Italia S.p.A.

Via Modena, 68
40017 S. Giovanni in Persiceto (BO) Italy
Tel.: +39 051 6812411
Fax.: +39 051 821898
info@assaabloy.it



Bologna Unit:

Via del Tuscolano, 6
40128 Bologna Italy
Tel.: +39 051 3540711
Fax.: +39 051 325108